

# Flexible Couplings RDA ... ESO

Design RDA ... ESO-GJS-2PE ...

Hub with mounting flange with through bores

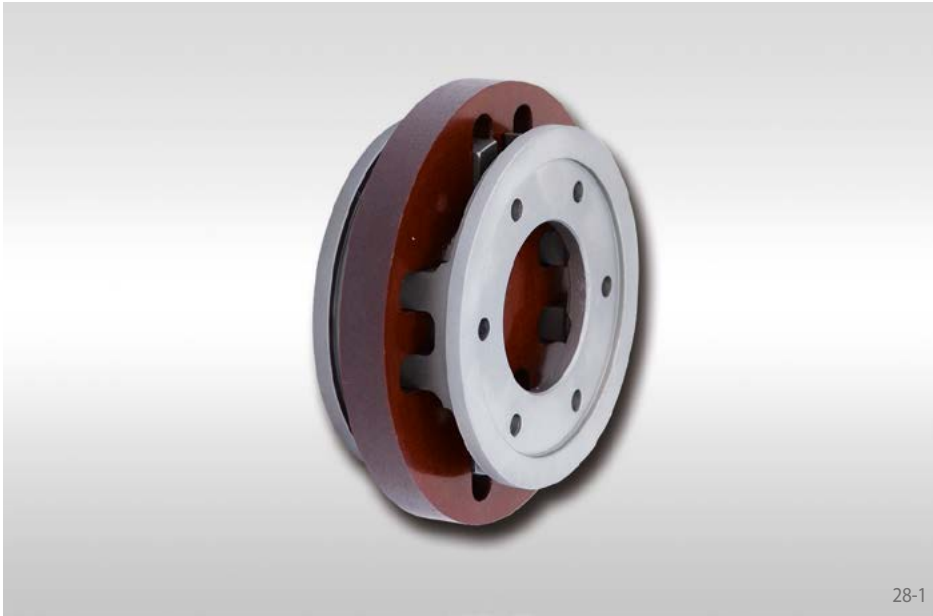

28-1

## Features

- Compact design
- Simple robust design
- Electrical insulation
- No stick-slip effect
- Large radial shaft misalignment permissible
- Torsionally rigid
- Minimal restoring forces to adjacent machine parts
- Typical applications: Printing machines, machine tools

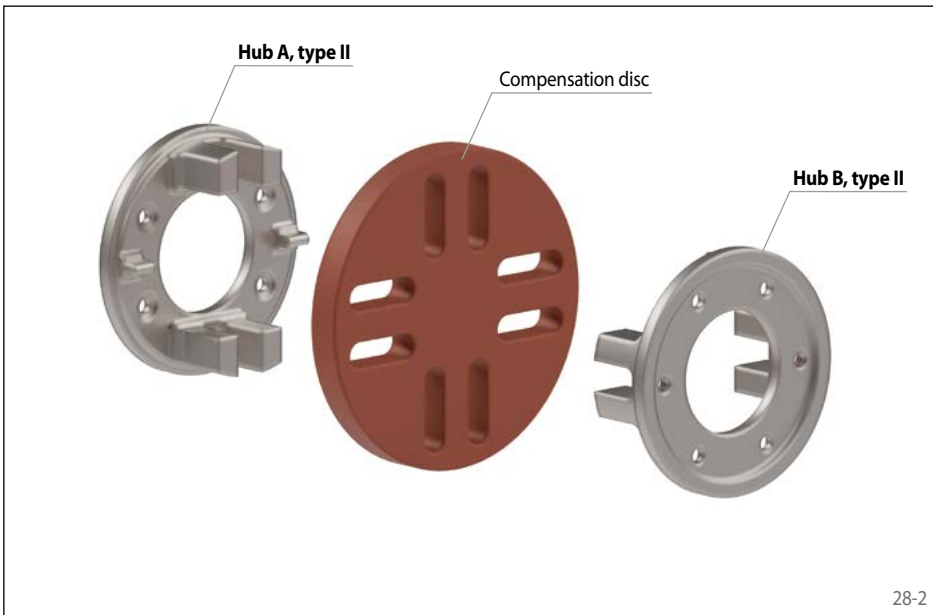

28-2

## Order example

	Code
Coupling design	RDA
Coupling size	0110
Type	ESO
Material of the hub: • Nodular cast iron	GJS
Hub A, type: • II, flange hub	2
Hub A, design: • Mounting flange with through bore, arrangement of the fastening holes according to hole pattern	PE
Pitch diameter T hub A	180
Hub B, type: • II, flange hub	2
Hub B, design: • Mounting flange with through bore, arrangement of the fastening holes according to hole pattern	PE
Pitch diameter T hub B	180
Material of the compensation disc: • HGW 2082 in accordance with DIN 7735	HG82

RDA 0110 ESO-GJS-2PE180-2PE180-HG82

## Design RDA ... ESO-GJS-2PE ...

### Hub with mounting flange with through bores

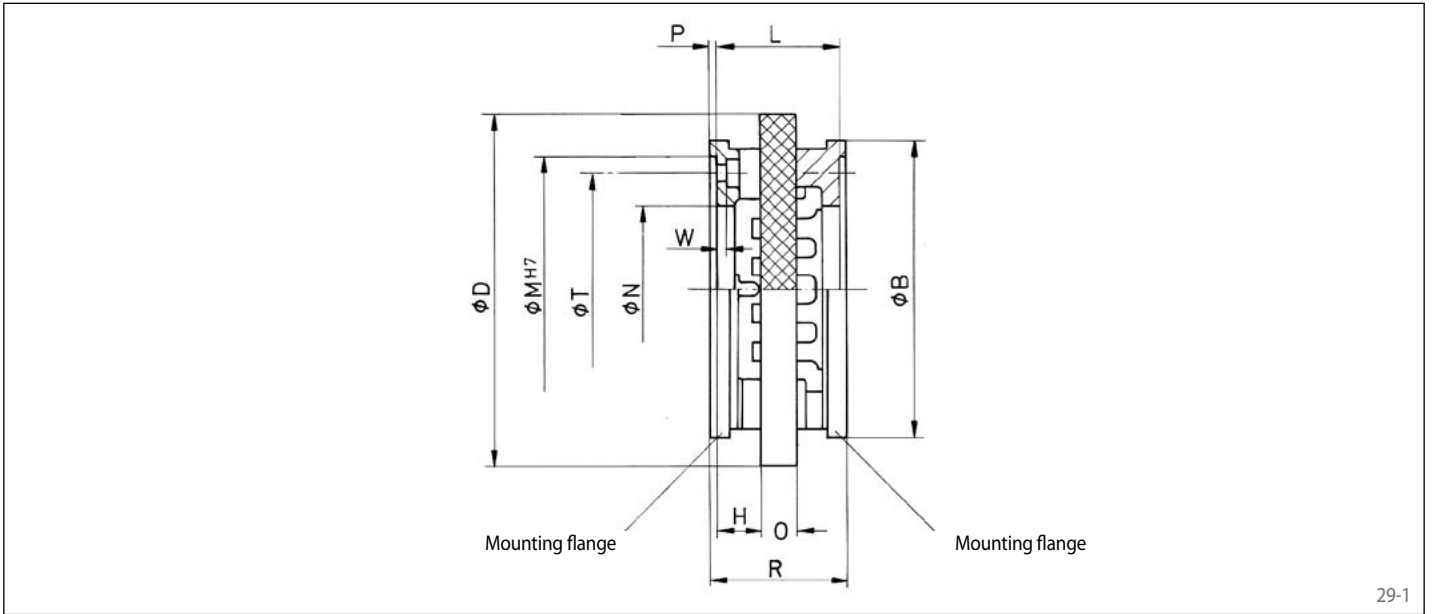

29-1

Coupling size	Max. torque $T_{Kmax}$ Nm	Max. speed $n_{max}$ $min^{-1}$	Moment of inertia $J_K$ $kgm^2$	Max. misalignments*		B mm	D mm	H mm	L mm	$M^{H7}$ mm	N mm	O mm	P mm	R mm	T mm	W mm	Z	Hole pattern**	Weight with rough bore kg
				Axial +/- mm	Radial mm														
0035	85	4100	0,0009	1,50	1,75	90	110	14,5	41	75	45	12	2,5	46	65	3,5	M 6	1	0,7
0042	190	3400	0,0026	1,50	2,1	110	135	15,5	45	90	52	14	2,5	50	75	4,5	M 6	2	1,4
0050	500	2670	0,0053	2,00	2,5	135	160	18,0	52	100	65	16	4,5	61	88	4,5	M 8	2	1,9
0051	500	2670	0,0051	2,00	2,5	135	160	17,5	51	125	76	16	3,0	57	108	5,0	M 8	3	1,7
0070	1000	2140	0,0138	2,00	3,5	163	200	21,0	62	135	90	20	4,0	70	115	5,5	M 10	2	3,2
0090	2000	1700	0,0453	2,50	4,5	202	250	26,5	78	170	104	25	4,5	87	150	7,0	M 10	4	7,0
0110	4000	1350	0,1314	4,00	5,5	254	315	32,0	96	200	146	32	5,0	106	180	5,0	M 12	3	12,3
0140	8000	1050	0,5203	4,50	7,0	330	400	44,0	128	250	157	40	5,0	138	225	8,0	M 16	3	31,2

\* max. angular displacement 3°.

\*\* Arrangement of the fastening holes for screws Z (DIN EN ISO 4762) on pitch diameter T. The hole pattern of the respective other coupling half is offset by 90°.

Elastomer element	Material	Temperature range °C	Colour
HGW 2082	Cotton fabric-phenolic	up to +100	red

### Arrangement of the fastening holes

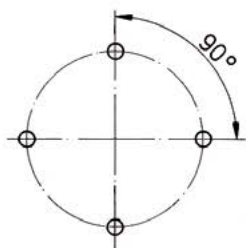

Hole pattern 1

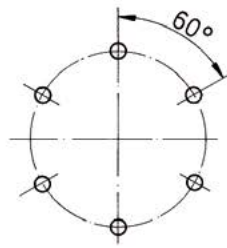

Hole pattern 2

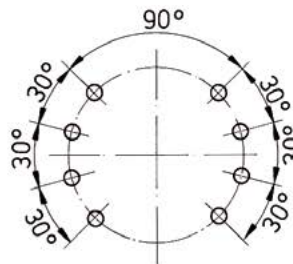

Hole pattern 3

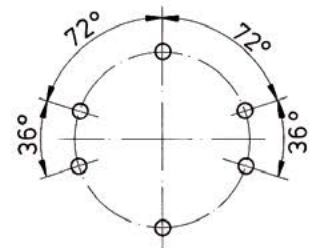

Hole pattern 4